

VL-CT35 Series Specifications

Parameter	Value	Units	
Configuration & Physical Parameters			
Motor	Animatics SmartMotors Size 23	-	
Coupling	Beam	-	
Ball Screw Leads	12	mm/rev	
Position Sensors	consult factory	-	
Stroke Lengths	50, 100 and 150	mm	
Overall Length	Stroke + 244.9	mm	
Over-Travel	0	mm	
Unit Mass	1.1667 + (stroke, mm)*0.003	kg	
Performance			
Unidirectional Repeatability	20	µm	
Bi-directional Repeatability	40	µm	
Accuracy	0.021/300	mm/mm	
Max Velocity	470 -1000 (stroke dependant)	mm/s	
Max Acceration	0.3	G	
Payload Mass	5.6	kg	
Rated Velocity	400	mm/s	
Lifetime*	15000	hr	
Load Capacities, Dynamic			
Using SM2316DT-PLS2 motor	Direct Drive	2:1 pulley**	-
Max Continuous Thrust	245	490	N
Max Peak Thrust	394	565	N

* Based on operating at an average speed of the rated velocity at the given payload. The Lifetime will be significantly reduced operating above the Rated Velocity and/or given payload.

**Please see pages 22-23 for pulley offset CAD drawings.



VL-CT35 series

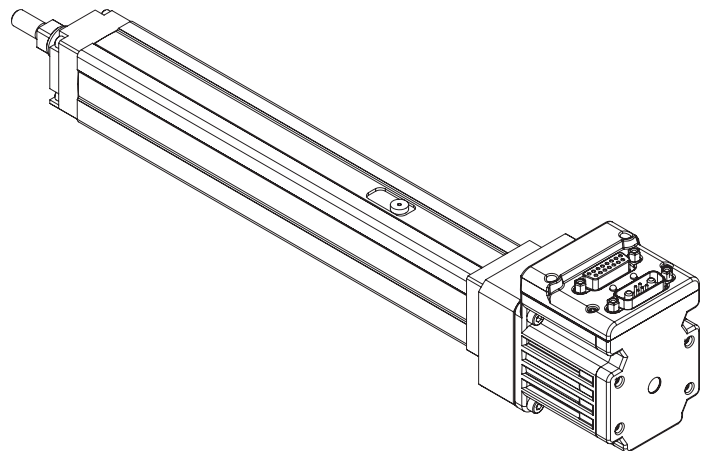

WARNING: Do not exceed these limits

VL-CT series - Maximum Permissible Carriage Velocity

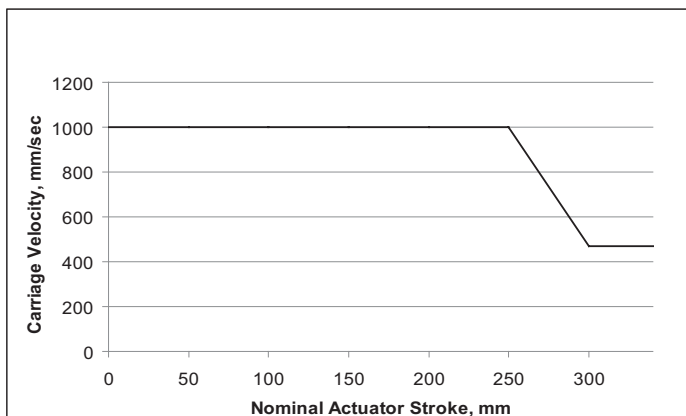

VL-CT series - Maximum Permissible Screw Speed

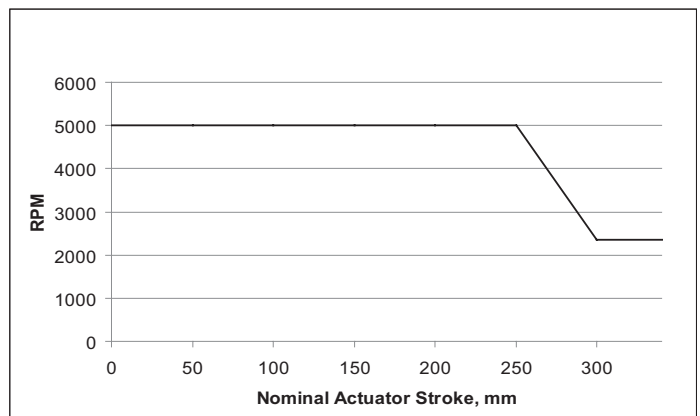

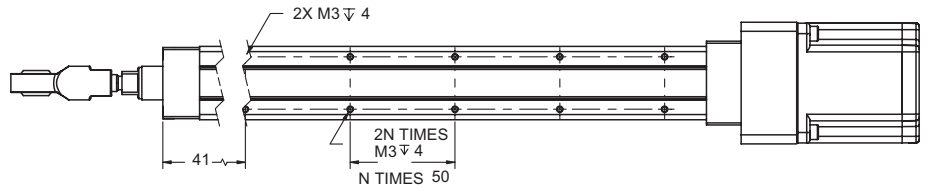
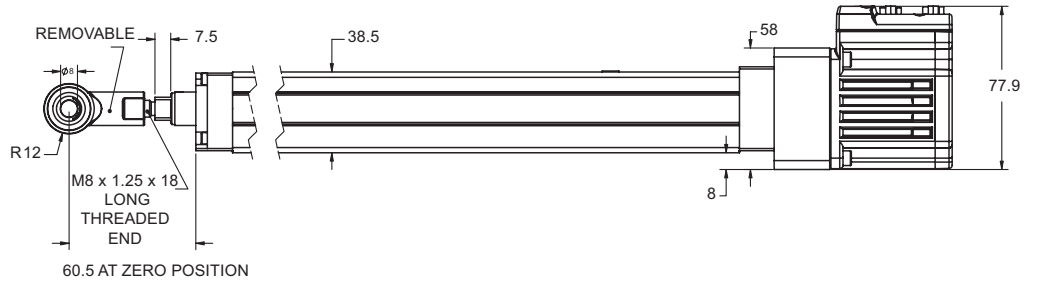
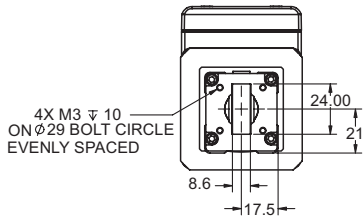
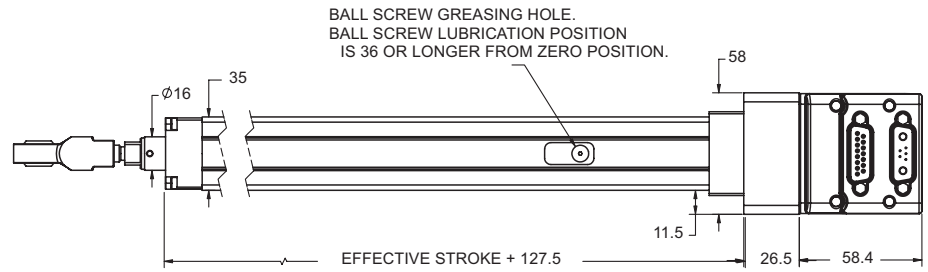

Dimensions in millimeters

Note: For part numbers please refer to our Website at www.oemdynamics.com/partnumbers or to catalog page 5.

Thrust Curve performance data in following section on pages 50-55.